

*Dental
Instruments
Catalog*

Retractors

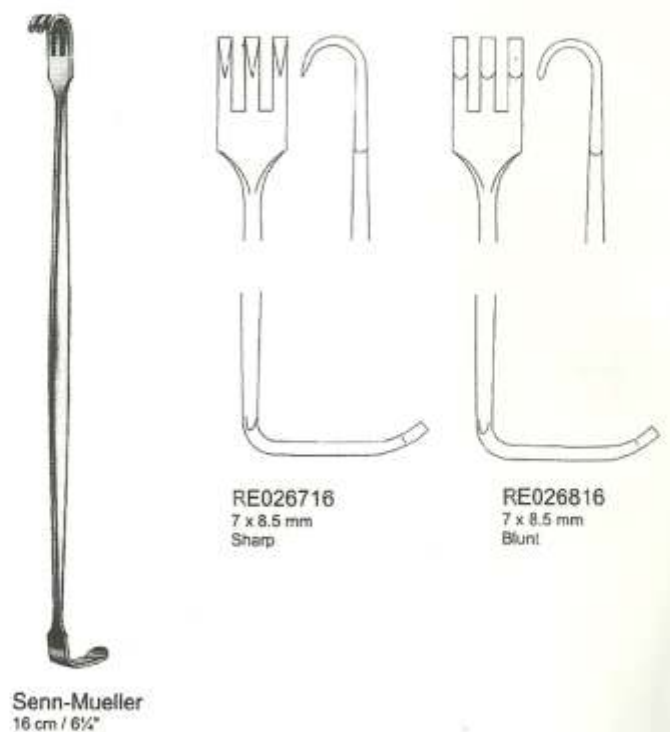
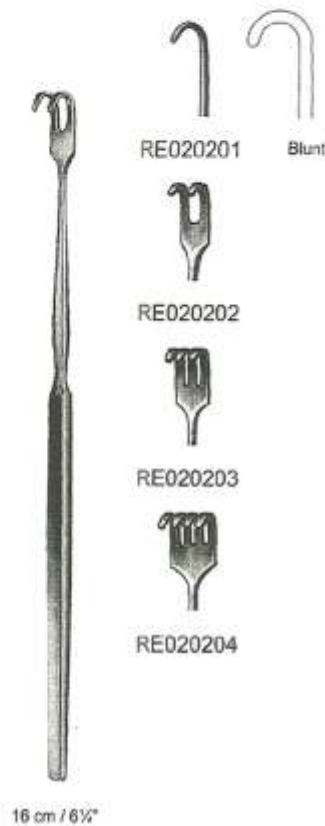
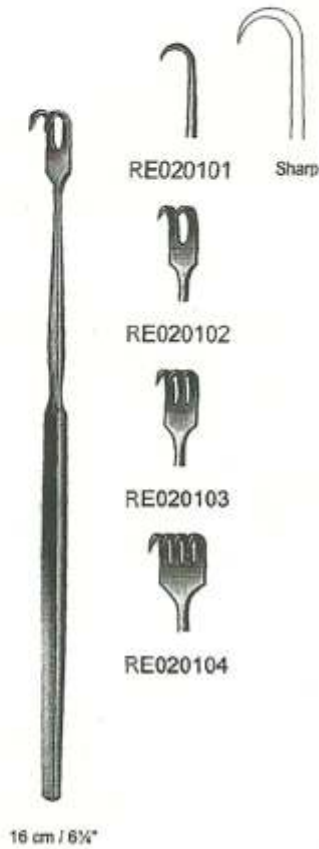

Retractors

Retractors, Skin Hooks
Wundhaken, Hauthakchen
separadors, Ganchos



Volkman
21.5 cm / 8 1/2"



RE032101



RE032102



RE032103



RE032104



Sharp



RE032201



RE032202



RE032203



RE032204



Blunt



Frazier
13 cm / 5 1/4"



RD093613
Sharp



RD093813
Blunt



Kilner
RH030415
15 cm / 6"



Gillies
18 cm / 7"



RH030818



RH031018



Guthrie
RD080112
12 cm / 4 3/4"



Guthrie
RD080313
13 cm / 5 1/4"

Retractors

Soft Tissue Retractors

Weichteilhaken

Separadored



Langenbeck
21 cm / 8 1/4"



RE039401
30 x 11 mm



RE039402
30 x 14 mm



RE039403
30 x 16 mm

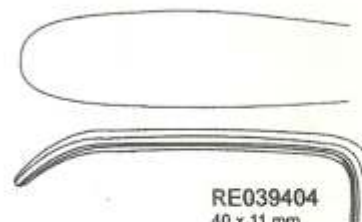

RE039404
40 x 11 mm

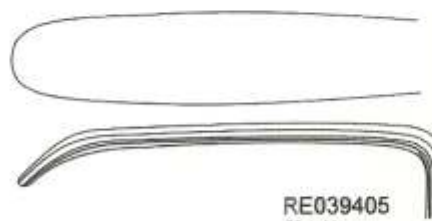

RE039405
50 x 11 mm

Retractors

Soft Tissue Retractors

Weichteilhaken

Separadored

Retractors

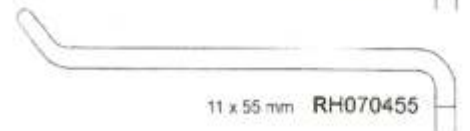
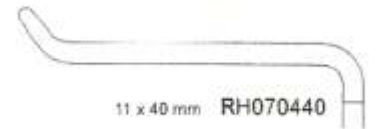
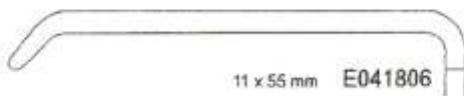
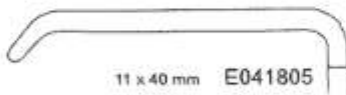
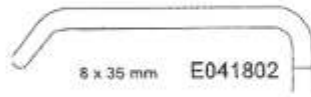
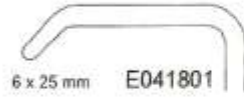

Obwegeser
(Kocher-Langenbeck)
21.5 cm / 8 1/2"



Obwegeser
22 cm / 8 3/4"

Retractors

Soft Tissue Retractors
Weichteilhaken
Separadored



Kocher
19 cm / 7 1/2"



RE042601
19 x 12 mm

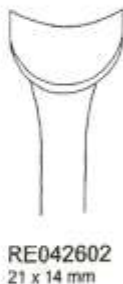

RE042602
21 x 14 mm



Kocher
22 cm / 8 3/4"



RE045201
40 x 10 mm



RE045202
40 x 15 mm



RE045203
40 x 20 mm



Middeldorpf



RE046201
21.5 cm / 8 3/4"
14 x 17 mm

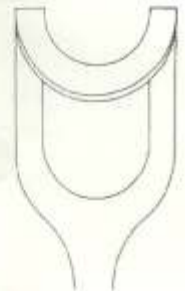

RE046202
22 cm / 8 3/4"
20 x 22 mm

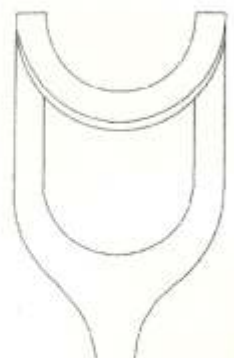

RE046203
23.5 cm / 9 1/4"
26 x 30 mm

Retractors

Soft Tissue Retractors
Weichteilhaken
Separadored



Fig. 2 = 30 x 10 mm
Fig. 1 = 26 x 10 mm

Fig. 1 = 30 x 13 mm
Fig. 2 = 34 x 13 mm

Farabeuf
RE076400
12 cm / 4 3/4"
Set of 2

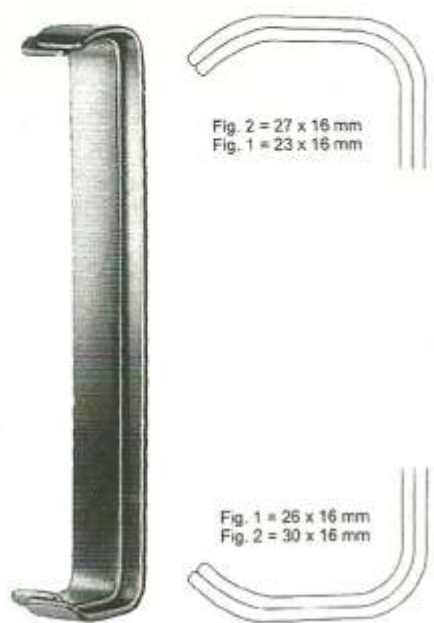

Fig. 2 = 27 x 16 mm
Fig. 1 = 23 x 16 mm

Fig. 1 = 26 x 16 mm
Fig. 2 = 30 x 16 mm

Farabeuf
RE076600
15 cm / 6"
Set of 2



Mini-Roux
RE076806
14 cm / 5 1/2"

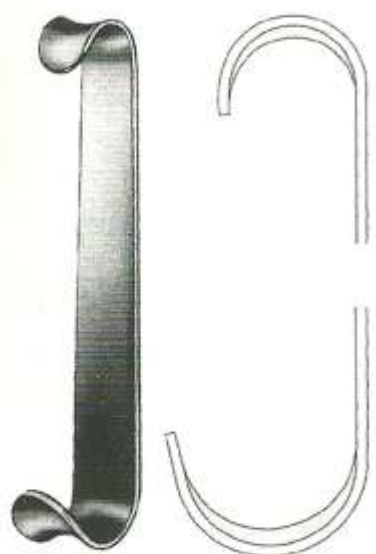

Baby-Roux
RE077013
13 cm / 5 1/4"



Roux
RE075600
Set of 3
Fig. 1 - Fig. 3

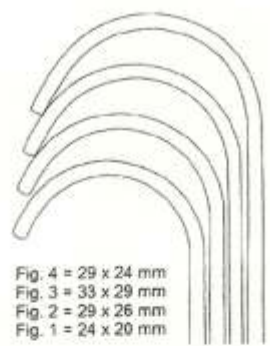

Fig. 4 = 29 x 24 mm
Fig. 3 = 33 x 29 mm
Fig. 2 = 29 x 26 mm
Fig. 1 = 24 x 20 mm

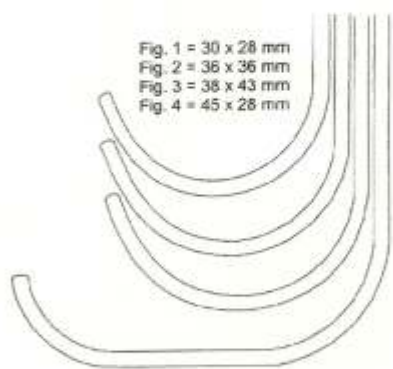

Fig. 1 = 30 x 28 mm
Fig. 2 = 36 x 36 mm
Fig. 3 = 38 x 43 mm
Fig. 4 = 45 x 28 mm

RE075601 Fig. 1 14 cm / 5 1/2"
RE075602 Fig. 2 15 cm / 6"
RE075603 Fig. 3 17 cm / 6 3/4"
RE075604 Fig. 4 18 cm / 7"

Retractors
Soft Tissue Retractors
Weichteilhaken
Separadored



Parker
RE077401
13.5 cm / 5 1/4"
Set of 2



Fig. 2 = 22 x 15 mm
Fig. 1 = 19 x 15 mm

Fig. 1 = 19 x 15 mm
Fig. 2 = 22 x 15 mm



Parker
RE077402
18 cm / 7"
Set of 2



Fig. 1 = 26 x 25 mm
Fig. 2 = 29 x 25 mm

Fig. 2 = 27 x 25 mm
Fig. 1 = 24 x 25 mm



Goelet
RE079600
19 cm / 7 1/2"



40 x 40 mm

30 x 30 mm

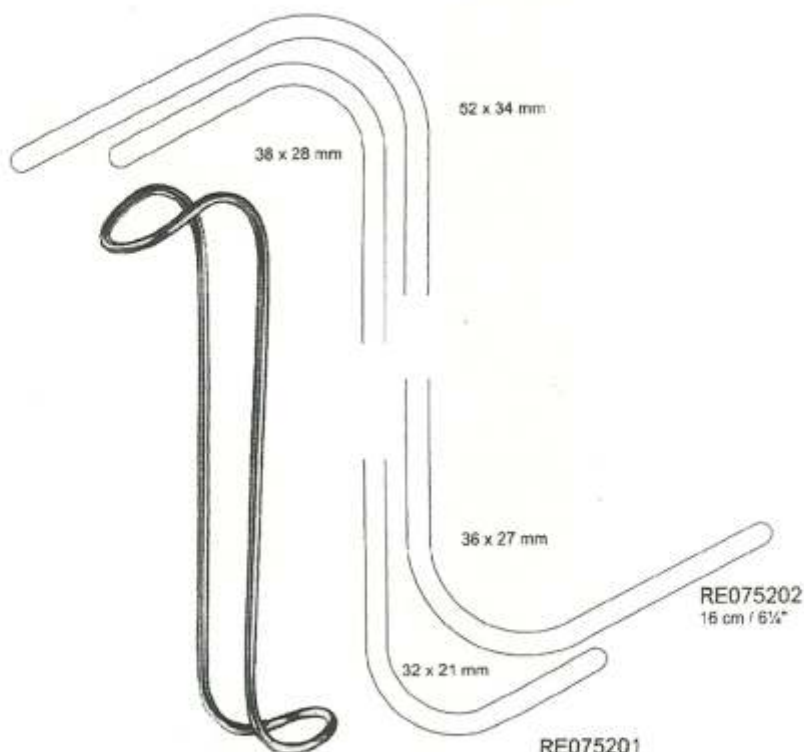

Collin-Hartmann

38 x 28 mm

52 x 34 mm

36 x 27 mm

32 x 21 mm

RE075202
16 cm / 6 1/4"

RE075201
14 cm / 5 1/2"



Soft
RE107412 20 cm / 8", 12 mm
RE107417 20 cm / 8", 17 mm
RE107425 25 cm / 10", 25 mm

Malleable and very soft
RE107606 6.5 mm
RE107609 9.5 mm
RE107613 13 mm
RE107616 16 mm
RE107619 19 mm
RE107625 25 mm
20 cm / 8"